



FDMS2572

N-Channel UltraFET Trench® MOSFET

150V, 27A, 47mΩ

Features

- Max $r_{DS(on)}$ = 47mΩ at $V_{GS} = 10V$, $I_D = 4.5A$
- Max $r_{DS(on)}$ = 53mΩ at $V_{GS} = 6V$, $I_D = 4.5A$
- Low Miller Charge
- Optimized efficiency at high frequencies
- UIS Capability (Single pulse and Repetitive pulse)
- RoHS Compliant



General Description

UltraFET devices combine characteristics that enable benchmark efficiency in power conversion applications. Optimized for $r_{DS(on)}$, low ESR, low total and Miller gate charge, these devices are ideal for high frequency DC to DC converters.

Application

- Distributed Power Architectures and VRMs
- Primary Switch for 24V and 48V Systems
- High Voltage Synchronous Rectifier

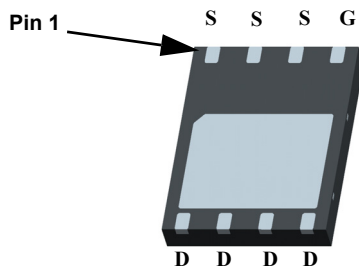

Power 56 (Bottom view)

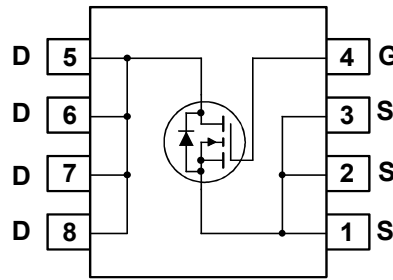

MOSFET Maximum Ratings $T_A = 25^\circ\text{C}$ unless otherwise noted

| Symbol | Parameter | Ratings | Units |
|----------------|--|-------------|------------------|
| V_{DS} | Drain to Source Voltage | 150 | V |
| V_{GS} | Gate to Source Voltage | ± 20 | V |
| I_D | Drain Current -Continuous (Package limited) $T_C = 25^\circ\text{C}$ | 27 | A |
| | -Continuous (Silicon limited) $T_C = 25^\circ\text{C}$ | 27 | |
| | -Continuous $T_A = 25^\circ\text{C}$ (Note 1a) | 4.5 | |
| | -Pulsed | 30 | |
| P_D | Power Dissipation $T_C = 25^\circ\text{C}$ | 78 | W |
| | Power Dissipation $T_A = 25^\circ\text{C}$ (Note 1a) | 2.5 | |
| T_J, T_{STG} | Operating and Storage Junction Temperature Range | -55 to +150 | $^\circ\text{C}$ |

Thermal Characteristics

| | | | |
|-----------------|---|-----|--------------------|
| $R_{\theta JC}$ | Thermal Resistance, Junction to Case | 1.6 | $^\circ\text{C/W}$ |
| $R_{\theta JA}$ | Thermal Resistance, Junction to Ambient (Note 1a) | 50 | |

Package Marking and Ordering Information

| Device Marking | Device | Package | Reel Size | Tape Width | Quantity |
|----------------|----------|----------|-----------|------------|------------|
| FDMS2572 | FDMS2572 | Power 56 | 13" | 12mm | 3000 units |

Electrical Characteristics $T_J = 25^\circ\text{C}$ unless otherwise noted

| Symbol | Parameter | Test Conditions | Min | Typ | Max | Units |
|--------|-----------|-----------------|-----|-----|-----|-------|
|--------|-----------|-----------------|-----|-----|-----|-------|

Off Characteristics

| | | | | | | |
|--------------------------------------|---|---|-----|-----|-----------|----------------------------|
| BV_{DSS} | Drain to Source Breakdown Voltage | $I_D = 250\mu\text{A}, V_{GS} = 0\text{V}$ | 150 | | | V |
| $\frac{\Delta BV_{DSS}}{\Delta T_J}$ | Breakdown Voltage Temperature Coefficient | $I_D = 250\mu\text{A}$, referenced to 25°C | | 180 | | $\text{mV}/^\circ\text{C}$ |
| I_{DSS} | Zero Gate Voltage Drain Current | $V_{DS} = 120\text{V}, V_{GS} = 0\text{V}$ | | | 1 | μA |
| I_{GSS} | Gate to Source Leakage Current | $V_{GS} = \pm 20\text{V}, V_{DS} = 0\text{V}$ | | | ± 100 | nA |

On Characteristics (Note 2)

| | | | | | | |
|--|--|---|---|------|-----|----------------------------|
| $V_{GS(th)}$ | Gate to Source Threshold Voltage | $V_{GS} = V_{DS}, I_D = 250\mu\text{A}$ | 2 | 3 | 4 | V |
| $\frac{\Delta V_{GS(th)}}{\Delta T_J}$ | Gate to Source Threshold Voltage Temperature Coefficient | $I_D = 250\mu\text{A}$, referenced to 25°C | | -9.8 | | $\text{mV}/^\circ\text{C}$ |
| $r_{DS(on)}$ | Drain to Source On Resistance | $V_{GS} = 10\text{V}, I_D = 4.5\text{A}$ | | 36 | 47 | m Ω |
| | | $V_{GS} = 6\text{V}, I_D = 4.5\text{A}$ | | 39 | 53 | |
| | | $V_{GS} = 10\text{V}, I_D = 4.5\text{A}, T_J = 125^\circ\text{C}$ | | 69 | 103 | |
| g_{FS} | Forward Transconductance | $V_{DS} = 10\text{V}, I_D = 4.5\text{A}$ | | 14 | | S |

Dynamic Characteristics

| | | | | | | |
|-----------|------------------------------|--|--|------|------|----------|
| C_{iss} | Input Capacitance | $V_{DS} = 75\text{V}, V_{GS} = 0\text{V}, f = 1\text{MHz}$ | | 1960 | 2610 | pF |
| C_{oss} | Output Capacitance | | | 130 | 175 | pF |
| C_{rss} | Reverse Transfer Capacitance | | | 30 | 45 | pF |
| R_g | Gate Resistance | $f = 1\text{MHz}$ | | 1.3 | | Ω |

Switching Characteristics

| | | | | | | |
|--------------|-------------------------------|--|--|----|----|----|
| $t_{d(on)}$ | Turn-On Delay Time | $V_{DD} = 75\text{V}, I_D = 1.0\text{A}$ $V_{GS} = 10\text{V}, R_{GEN} = 6\Omega$ | | 11 | 20 | ns |
| t_r | Rise Time | | | 8 | 16 | ns |
| $t_{d(off)}$ | Turn-Off Delay Time | | | 38 | 61 | ns |
| t_f | Fall Time | | | 31 | 50 | ns |
| $Q_{g(TOT)}$ | Total Gate Charge at 10V | $V_{GS} = 0\text{V}$ to 10V | $V_{DD} = 75\text{V}$ $I_D = 4.5\text{A}$ | 31 | 43 | nC |
| Q_{gs} | Gate to Source Gate Charge | | | 9 | | nC |
| Q_{gd} | Gate to Drain "Miller" Charge | | | 7 | | nC |

Drain-Source Diode Characteristics

| | | | | | | |
|----------|---------------------------------------|--|--|-----|-----|----|
| V_{SD} | Source to Drain Diode Forward Voltage | $V_{GS} = 0\text{V}, I_S = 2.2\text{A}$ (Note 2) | | 0.7 | 1.0 | V |
| t_{rr} | Reverse Recovery Time | $I_F = 4.5\text{A}, di/dt = 100\text{A}/\mu\text{s}$ | | 67 | 101 | ns |
| Q_{rr} | Reverse Recovery Charge | | | 130 | 195 | nC |

Notes:

1: $R_{\theta JA}$ is determined with the device mounted on a 1in^2 pad 2 oz copper pad on a $1.5 \times 1.5\text{in.}$ board of FR-4 material. $R_{\theta JC}$ is guaranteed by design while $R_{\theta CA}$ is determined by the user's board design.

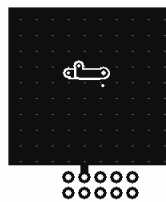

a. $50^\circ\text{C}/\text{W}$ when mounted on a 1in^2 pad of 2 oz copper



b. $125^\circ\text{C}/\text{W}$ when mounted on a minimum pad of 2 oz copper

2: Pulse Test: Pulse Width < $300\mu\text{s}$, Duty cycle < 2.0%.

Typical Characteristics $T_J = 25^\circ\text{C}$ unless otherwise noted

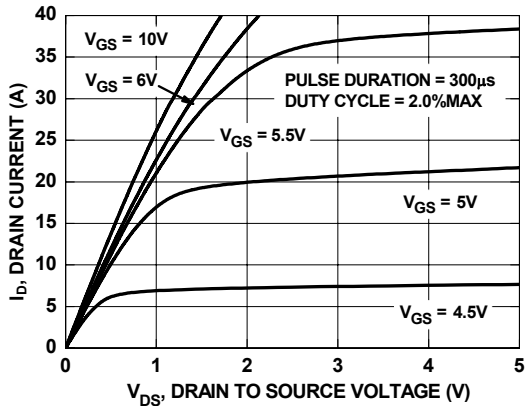

Figure 1. On-Region Characteristics

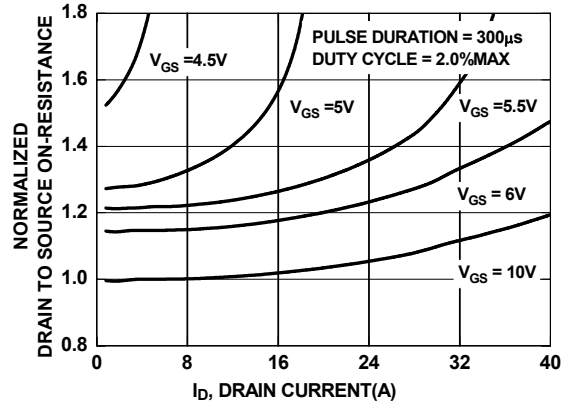

Figure 2. Normalized On-Resistance vs Drain Current and Gate Voltage

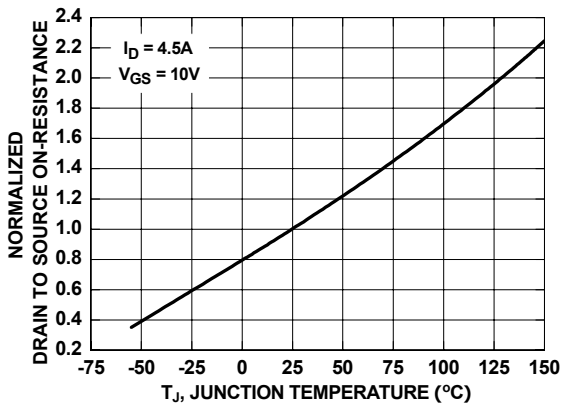

Figure 3. Normalized On-Resistance vs Junction Temperature

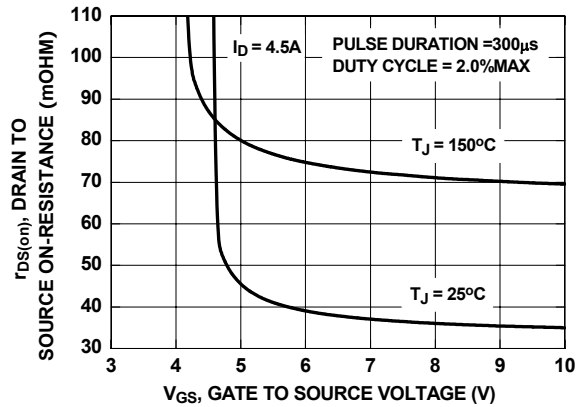

Figure 4. On-Resistance vs Gate to Source Voltage

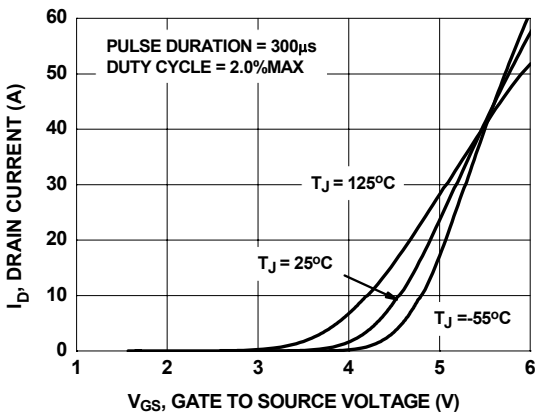

Figure 5. Transfer Characteristics

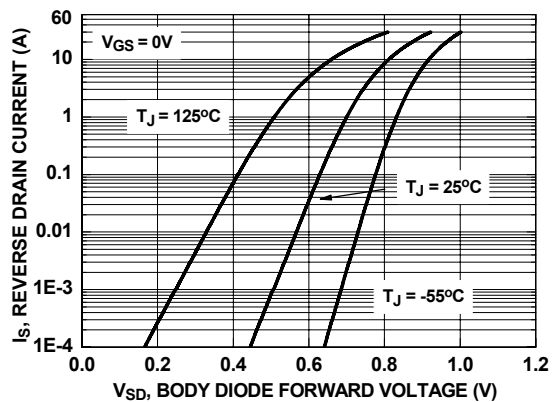

Figure 6. Source to Drain Diode Forward Voltage vs Source Current

Typical Characteristics $T_J = 25^\circ\text{C}$ unless otherwise noted

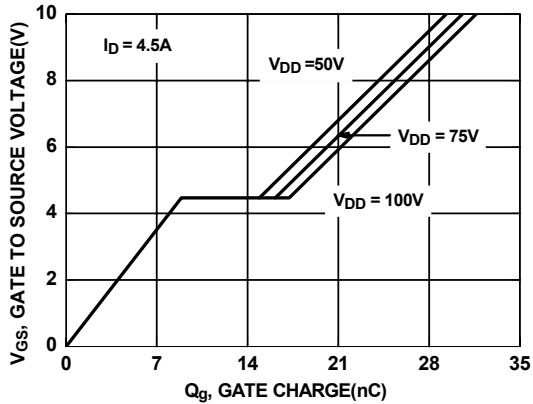

Figure 7. Gate Charge Characteristics

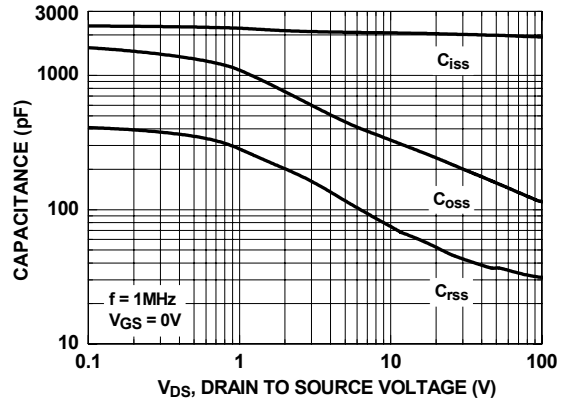

Figure 8. Capacitance vs Drain to Source Voltage

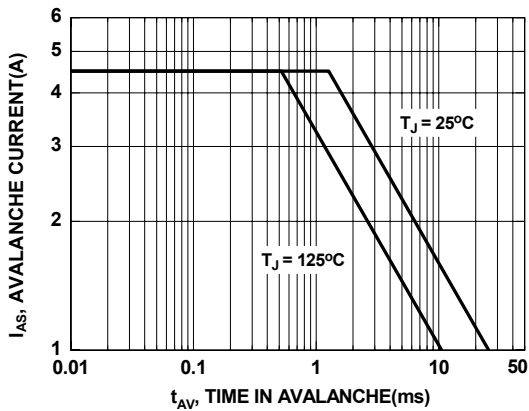

Figure 9. Unclamped Inductive Switching Capability

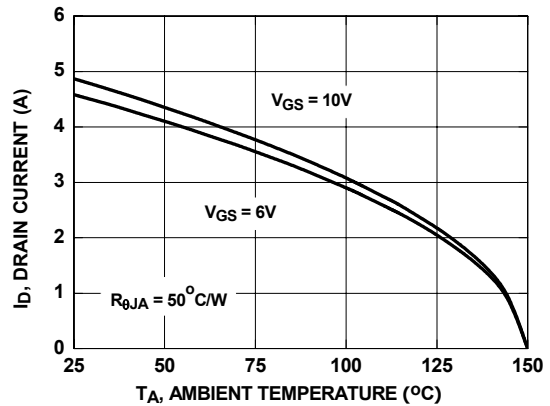

Figure 10. Maximum Continuous Drain Current vs Ambient Temperature

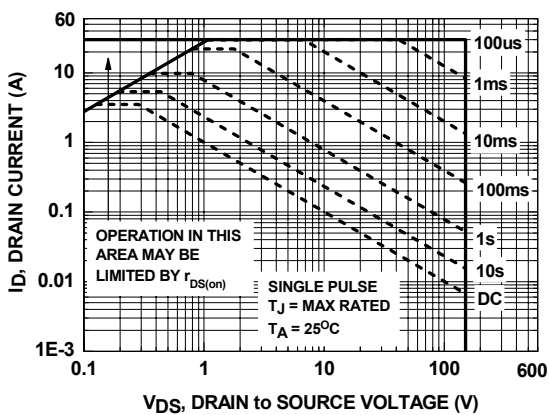

Figure 11. Forward Bias Safe Operating Area

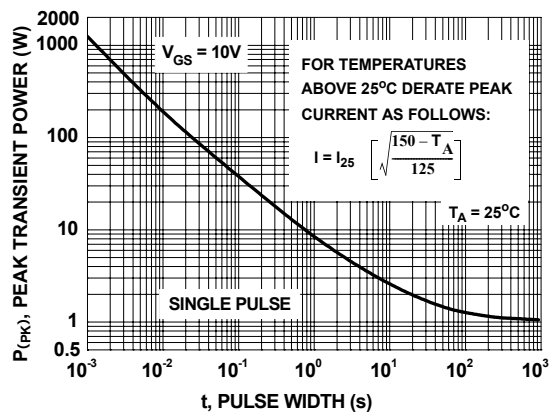

Figure 12. Single Pulse Maximum Power Dissipation

Typical Characteristics $T_J = 25^\circ\text{C}$ unless otherwise noted

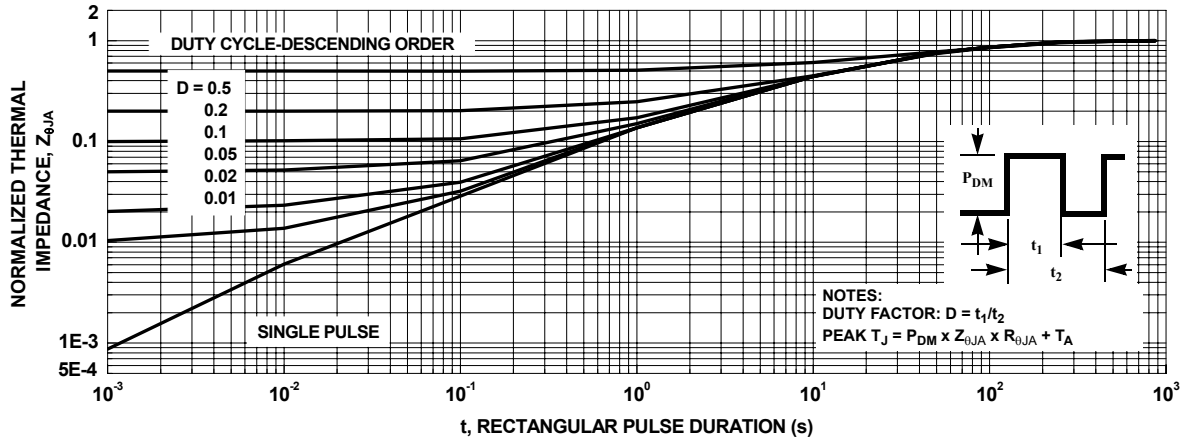
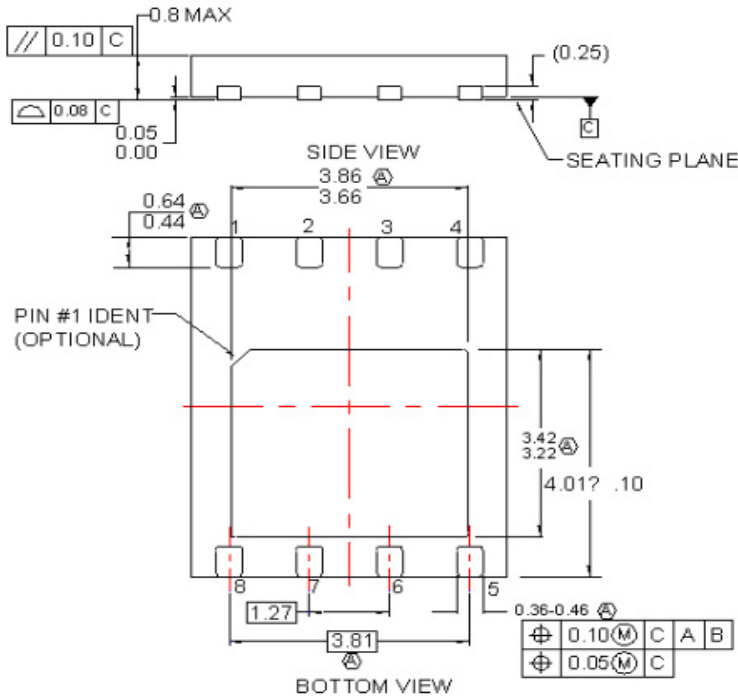
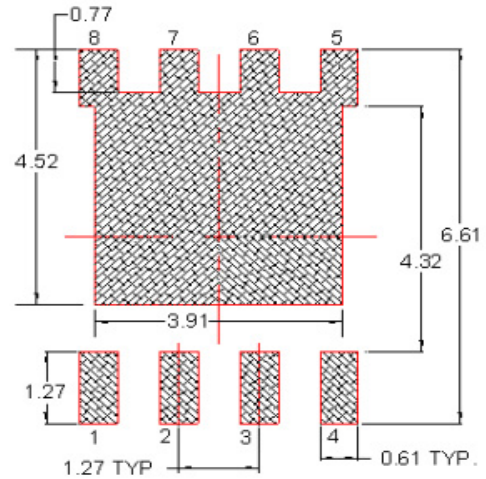
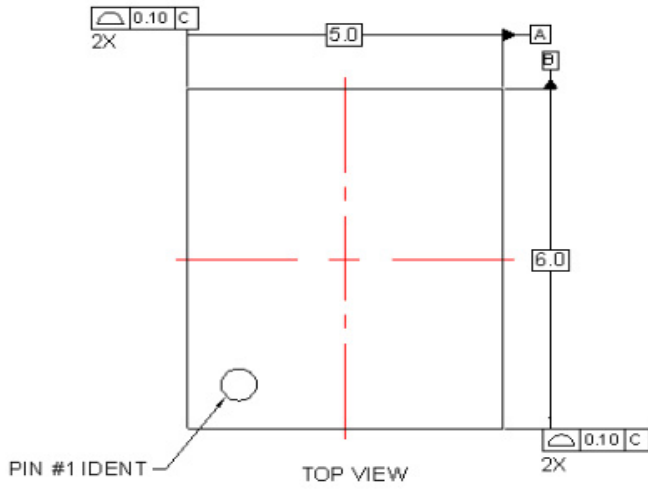

Figure 13. Transient Thermal Response Curve



NOTES:

- (A) DOES NOT FULLY CONFORM TO JEDEC REGISTRATION, MO-229, DATED 11/2001.
- B. DIMENSIONS ARE IN MILLIMETERS.
- C. DIMENSIONS AND TOLERANCES PER ASME Y14.5M, 1994
- D. TERMINALS 5,6,7 AND 8 ARE TIED TO THE EXPOSED PADDLE

MLP08GrevD

TRADEMARKS

The following are registered and unregistered trademarks Fairchild Semiconductor owns or is authorized to use and is not intended to be an exhaustive list of all such trademarks.

| | | | | |
|--|---------------------------------|---------------------------------|------------------------------|---------------------|
| ACEx [™] | FACT Quiet Series [™] | OCX [™] | SILENT SWITCHER [®] | UniFET [™] |
| ActiveArray [™] | GlobalOptoisolator [™] | OCXPro [™] | SMART START [™] | VCX [™] |
| Bottomless [™] | GTO [™] | OPTOLOGIC [®] | SPM [™] | Wire [™] |
| Build it Now [™] | HiSeC [™] | OPTOPLANAR [™] | Stealth [™] | |
| CoolFET [™] | I ² C [™] | PACMAN [™] | SuperFET [™] | |
| CROSSVOLT [™] | <i>i-Lo</i> [™] | POPT [™] | SuperSOT [™] -3 | |
| DOME [™] | ImpliedDisconnect [™] | Power247 [™] | SuperSOT [™] -6 | |
| EcoSPARK [™] | IntelliMAX [™] | PowerEdge [™] | SuperSOT [™] -8 | |
| E ² CMOST [™] | ISOPLANAR [™] | PowerSaver [™] | SyncFET [™] | |
| EnSigna [™] | LittleFET [™] | PowerTrench [®] | TCM [™] | |
| FACT [®] | MICROCOUPLER [™] | QFET [®] | TinyBoost [™] | |
| FAST [®] | MicroFET [™] | QS [™] | TinyBuck [™] | |
| FASTr [™] | MicroPak [™] | QT Optoelectronics [™] | TinyPWM [™] | |
| FPST [™] | MICROWIRE [™] | Quiet Series [™] | TinyPower [™] | |
| FRFET [™] | MSX [™] | RapidConfigure [™] | TinyLogic [®] | |
| | MSXPro [™] | RapidConnect [™] | TINYOPTO [™] | |
| Across the board. Around the world. [™] | | μSerDes [™] | TruTranslation [™] | |
| The Power Franchise [®] | | ScalarPump [™] | UHC [®] | |
| Programmable Active Droop [™] | | | | |

DISCLAIMER

FAIRCHILD SEMICONDUCTOR RESERVES THE RIGHT TO MAKE CHANGES WITHOUT FURTHER NOTICE TO ANY PRODUCTS HEREIN TO IMPROVE RELIABILITY, FUNCTION OR DESIGN. FAIRCHILD DOES NOT ASSUME ANY LIABILITY ARISING OUT OF THE APPLICATION OR USE OF ANY PRODUCT OR CIRCUIT DESCRIBED HEREIN; NEITHER DOES IT CONVEY ANY LICENSE UNDER ITS PATENT RIGHTS, NOR THE RIGHTS OF OTHERS. THESE SPECIFICATIONS DO NOT EXPAND THE TERMS OF FAIRCHILD'S WORLDWIDE TERMS AND CONDITIONS, SPECIFICALLY THE WARRANTY THEREIN, WHICH COVERS THESE PRODUCTS.

LIFE SUPPORT POLICY

FAIRCHILD'S PRODUCTS ARE NOT AUTHORIZED FOR USE AS CRITICAL COMPONENTS IN LIFE SUPPORT DEVICES OR SYSTEMS WITHOUT THE EXPRESS WRITTEN APPROVAL OF FAIRCHILD SEMICONDUCTOR CORPORATION.

As used herein:

1. Life support devices or systems are devices or systems which, (a) are intended for surgical implant into the body, or (b) support or sustain life, or (c) whose failure to perform when properly used in accordance with instructions for use provided in the labeling, can be reasonably expected to result in significant injury to the user.
2. A critical component is any component of a life support device or system whose failure to perform can be reasonably expected to cause the failure of the life support device or system, or to affect its safety or effectiveness.

PRODUCT STATUS DEFINITIONS

Definition of Terms

| Datasheet Identification | Product Status | Definition |
|--------------------------|------------------------|---|
| Advance Information | Formative or In Design | This datasheet contains the design specifications for product development. Specifications may change in any manner without notice. |
| Preliminary | First Production | This datasheet contains preliminary data, and supplementary data will be published at a later date. Fairchild Semiconductor reserves the right to make changes at any time without notice in order to improve design. |
| No Identification Needed | Full Production | This datasheet contains final specifications. Fairchild Semiconductor reserves the right to make changes at any time without notice in order to improve design. |
| Obsolete | Not In Production | This datasheet contains specifications on a product that has been discontinued by Fairchild semiconductor. The datasheet is printed for reference information only. |

Rev. 122